

## Surgical Technique



Acumed® is a global leader of innovative orthopaedic and medical solutions.



We are dedicated to developing products, service methods, and approaches that improve patient care.



## Acumed® Anatomic Radial Head Solutions

The Acumed Anatomic Radial Head System is designed to provide an anatomic implant to replace the patient's native radial head. Designed in conjunction with Shawn W. O'Driscoll, PhD, MD, the Acumed Anatomic Radial Head System features 290 head and stem combinations including standard stems, long stems, an anatomically shaped radial head, and system-specific instrumentation to help streamline the surgeon's experience in the operating room.

### Indications for Use:

- ▶ Replacement of the radial head for degenerative or post-traumatic disabilities presenting pain, crepitation, and decreased motion of the radiohumeral and/or proximal radioulnar joint with joint destruction and/or subluxation, and resistance to conservative treatment.
- ▶ Primary replacement after fracture of the radial head.
- ▶ Symptomatic replacement after radial head resection.
- ▶ Revision following failed radial head arthroplasty.

In addition to the Anatomic Radial Head System, this set may include the Acutrak 2® Mini and Micro instruments and the Locking Radial Head Plate System at the base of the tray to provide multiple solutions all in one set. For the Acutrak 2 Headless Compression Screw System surgical technique, please reference part number SPF00-02. For the Locking Radial Head Plate System surgical technique, please reference part number ELB00-02.

	Definition
<b>Warning</b>	Indicates critical information about a potential serious outcome to the patient or the user.
<b>Caution</b>	Indicates instructions that must be followed in order to ensure the proper use of the device.
<b>Note</b>	Indicates information requiring special attention.

# Table of Contents

System Features .....	<b>2</b>
Instrument Overview .....	<b>6</b>
Surgical Technique Overview .....	<b>8</b>
Surgical Techniques .....	<b>10</b>
Anatomic Radial Head – Standard Stem .....	<b>10</b>
Anatomic Radial Head – Long Stem .....	<b>16</b>
Anatomic Radial Head and Stem Removal .....	<b>22</b>
Ordering Information .....	<b>23</b>
References .....	<b>28</b>

# System Features

## Radial Head Implants



**Head Implants: 20–28 mm**  
(TR-H200X-S–TR-H280X-S)

# System Features [continued]

## Standard Stem Implants

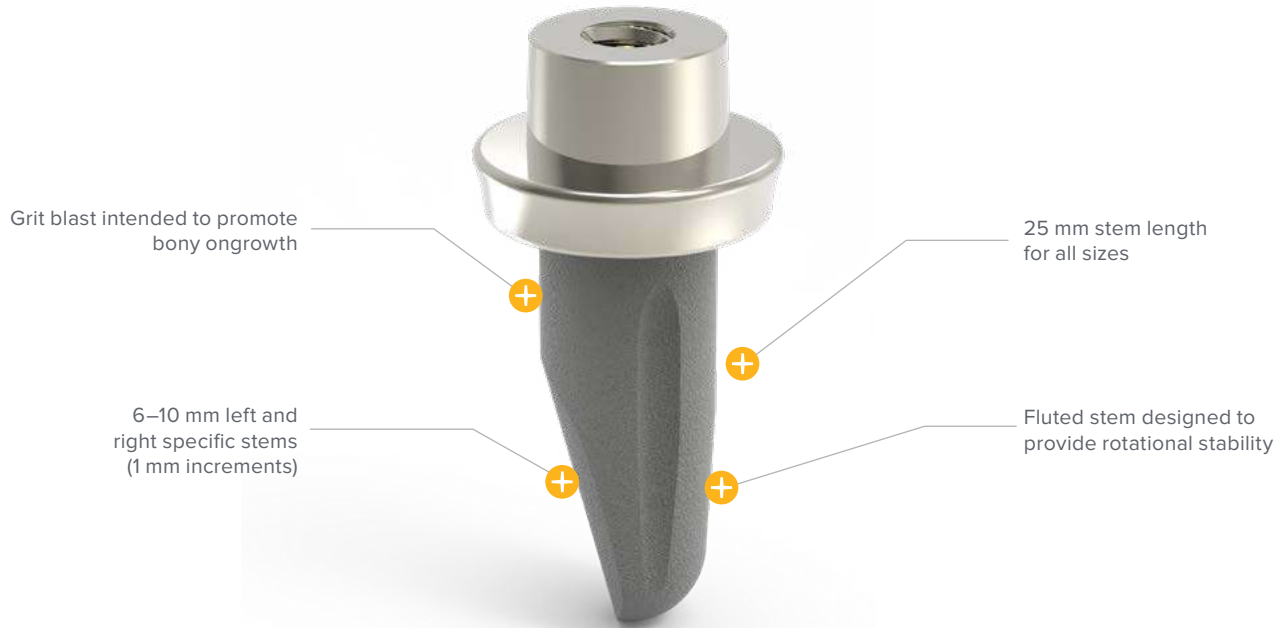

**Standard Stem Implants: 6–10 mm diameters (TR-SXXXX-S)**

# System Features [continued]

## Long Stem Implants



**Long Stem Implants: 6–12 mm diameters, (2 mm increments) (TR-SLXX-S)**

Stem Diameter	Resection Length	Stem Length	Grit Blast Length
6 mm	19 mm	50 mm	18 mm
8 mm	22 mm	55 mm	20 mm
10 mm	25 mm	60 mm	22 mm
12 mm	28 mm	65 mm	24 mm

# System Features [continued]

## Trial Heads and Stems



**Trial Heads: 20–28 mm**  
(TR-TH2XX)  
Left trial heads are blue, right trial heads are green



**Standard Trial Stems: 6–10 mm (1 mm increments)**  
(TR-TSXX)



**Long Stem Trials: 6–12 mm (2 mm increments)**  
(TR-TSLXXX)  
Left trial stems are blue, right trial stems are green

# Instrument Overview



**6.0 mm Stem Gauge**  
(TR-TGA06)



**Height Gauge**  
(TR-TG02)



**Bone Graft Ratcheting T-Handle**  
(BG-8043)

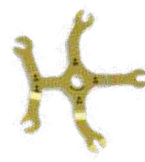

**ARH Standard & Optional Trial Gauge**  
(80-0832)



**Medium Ratcheting Driver Handle**  
(80-0663)



**AT2 Screw Sizer**  
(AT2-SMCZ)

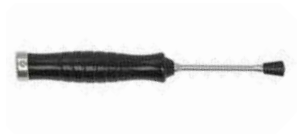

**Head Impactor**  
(TR-MS05)



**Long Stem Resection Guide (6 mm, 8 mm, 10 mm, 12 mm)**  
(80-1512)



**Long Stem Reamer 6 mm**  
(80-1706)



**Long Stem Reamer 8 mm**  
(80-1708)



**Long Stem Reamer 10 mm**  
(80-1710)



**Long Stem Reamer 12 mm**  
(80-1712)



**Morse Taper Impactor Block**  
(80-1506)



## Instrument Overview [continued]



**5.5 mm Quick Release Awl**  
(TR-0206)



**Radius Retractor**  
(80-1509)



**Cross Bar**  
(80-1771)



**6 mm Collar Reamer**  
(TR-CRA06)



**7 mm Collar Reamer**  
(TR-CRA07)



**8 mm Collar Reamer**  
(TR-CRA08)



**9 mm Collar Reamer**  
(TR-CRA09)



**10 mm Collar Reamer**  
(TR-CRA10)



**Standard Stem Reamer**  
**6 mm**  
(80-1606)



**Standard Stem Reamer**  
**7 mm**  
(80-1607)



**Standard Stem Reamer**  
**8 mm**  
(80-1608)



**Standard Stem Reamer**  
**9 mm**  
(80-1609)



**Standard Stem Reamer 10 mm**  
(80-1610)



**ARH Removal Tool Shaft**  
(80-2018)

# Surgical Technique Overview

## Anatomic Radial Head – Standard Stem Surgical Technique

Incision and Dissection



Radial Head Resection



Determine Stem Diameter



Ream with Collar Reamer



## Anatomic Radial Head – Long Stem Surgical Technique

Incision and Dissection



Radial Head/Neck Resection

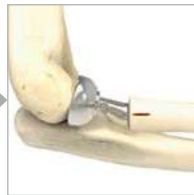

Determine Stem Diameter



Determine Head Diameter



## Anatomic Radial Head and Stem Removal Surgical Technique

Head Removal



Stem Removal



Determine Head Diameter



Assemble Head and Stem Gauge



Select Trial Implants and Assemble



Trial Implant Insertion



Implant Assembly



Implant Insertion



Select Trial Implants and Assemble

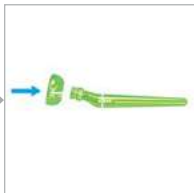

Trial Implant Insertion



Implant Assembly



Implant Insertion



# Anatomic Radial Head – Standard Stem Surgical Technique

Shawn W. O’Driscoll, PhD, MD

Figure 1

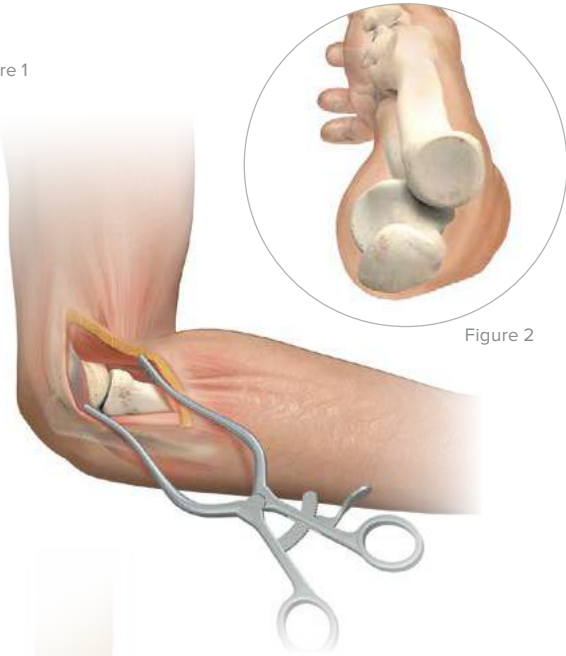

Figure 2

## 1 Incision and Dissection

There are several exposure options, depending on the integrity of the lateral soft tissues. In fracture-dislocations, the exposure is through the traumatic opening in the ligament complex. For delayed reconstructions, and in those acute cases in which the lateral collateral ligament is intact, the Kaplan interval permits the ligament to be left intact. The deep incision is placed in a line from the lateral epicondyle toward Lister’s tubercle, with the forearm in neutral rotation. Proximally, the extensor carpi radialis longus (ECRL) origin is released with the anterior capsule to permit direct access to the front of the radial head.

Figure 3



## 2 Radial Head Resection

Resect the radial head with a microsagittal saw at the distal limit of the fracture, or as proximal as possible without leaving a significant neck defect. A maximum length of 17 mm of the radius can be replaced. This 17 mm includes the radius length reamed with the collar reamer in Step 4. If longer than 17 mm resection is needed, long stems are available. While 17 mm is the maximum resection, 9 mm is required for the minimum resection.

# Anatomic Radial Head – Standard Stem Surgical Technique [continued]

## 3 Determine Stem Diameter

Use the 5.5 mm Quick Release Awl (TR-0206) to initially enter the canal. Assemble the Bone Graft Ratcheting T-Handle (BG-8043) to the Standard Stem Reamer 6 mm (80-1606) and prepare the canal for the stem using sequentially larger reamers until a tight fit is achieved. A Radius Retractor (80-1509) is available to elevate the radius. The proper reaming depth is achieved when the laser mark band is even with the level of resection.

**Note:** The standard stem reamers are 0.5 mm undersized from the implants.



Figure 4

## 4 Ream with Collar Reamer

Select the Collar Reamer (TR-CRAXX) that matches the stem diameter determined by the reamer in the previous step. Power ream the collar to create a surface with at least 60% of the radial shaft in contact with the reamer. Use caution to avoid fracturing the radial neck, which can occur if the reamer catches on irregular bone in the fracture surface. The risk of such fracturing can be lessened by reaming initially in the reverse direction, such that the reamer acts more as a power rasp.



Figure 5

## 5 Determine Head Diameter

Determine head diameter by placing the resected head upside down in the sizing pockets on the Morse Taper Impactor Block (80-1506). If between sizes, select the smaller diameter.



Figure 6



5.5 mm Quick Release Awl (TR-0206)



Bone Graft Ratcheting T-Handle (BG-8043)



Standard Stem Reamer 6 mm (80-1606)



Radius Retractor (80-1509)



Collar Reamer (TR-CRAXX)



Morse Taper Impactor Block (80-1506)

# Anatomic Radial Head – Standard Stem Surgical Technique [continued]

Figure 7



## 6 Assemble Head and Stem Gauge

Assemble the Height Gauge (TR-TG02) and 6.0 mm Stem Gauge Assembly (TR-TGA06). The height gauge needs to be completely compressed. Insert the 6.0 mm Stem Gauge Assembly into the bone canal.

Figure 8



## 7 Select Trial Implants and Assemble

Starting with the +0 end of the ARH Standard & Optional Trial Gauge (80-0832), sequentially increase the height by inserting the end of the gauge under the telescoping head of the assembly, until the head reaches the capitellum. It is critical that the coronoid contacts the trochlea during this process. Separation between the coronoid and the trochlea is an indicator that the collar is too large. The number on the trial gauge (+0, 2, 4, 6, 8 mm) will correspond to the collar height on the stem.



Height Gauge  
(TR-TG02)



6.0 mm Stem  
Gauge Assembly  
(TR-TGA06)



ARH Standard  
& Optional Trial  
Gauge  
(80-0832)

# Anatomic Radial Head – Standard Stem Surgical Technique [continued]

## 8 Select Trial Implants and Assemble

After selecting the Trial Head (TR-TH2XX) and Trial Stem (TR-TSXX or TR-TSXXX), align laser marks on the head and stem and assemble using hand pressure. The stem laser mark is indicated Left or Right (“L” or “R”) for proper orientation. If the trial head and stem are difficult to connect, apply saline solution prior to connecting.



## 9 Trial Implant Insertion

Insert the trial implant into the radius. Ensure that the laser marks on the head and stem are aligned with the lateral aspect of the radius when the forearm is in neutral position. Lister’s tubercle may also be used as a landmark for laser mark orientation. Check for proper articulation with the capitellum and the coronoid. The coronoid needs to be in contact with the trochlea to ensure proper positioning of the trial.

**Note:** Trial components are NOT designed to be implanted.

**Note:** The trial stem diameters are 0.5 mm undersized from the reamers for ease of insertion.

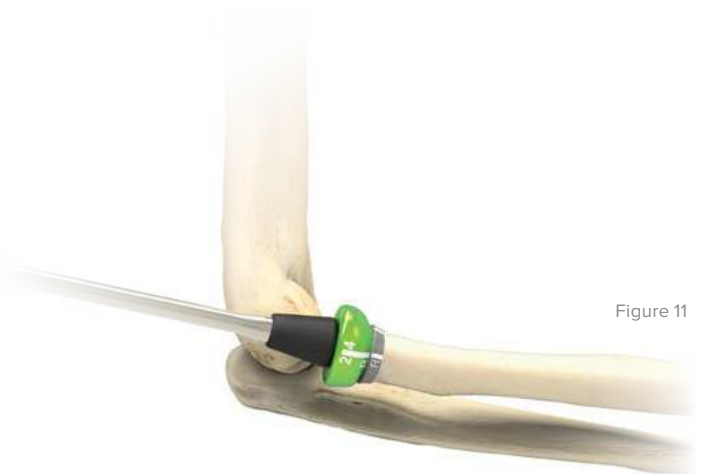

Trial Head  
(TR-TH2XX)



Trial Stem  
(TR-TSXX or  
TR-TSXXX)

# Anatomic Radial Head – Standard Stem Surgical Technique [continued]

Figure 12



Figure 13



Figure 14



Figure 15



## 10 Implant Assembly

After determining the correct size head and stem with the trials, place the Standard Stem Implant (TR-SXXXX-S) into the appropriate size hole in the Morse Taper Impactor Block (80-1506). Align laser marks and impact the Head Implant (TR-H2XXX-S) and Stem Implant, then lock the Morse Taper using the Head Impactor (TR-MS05) and a mallet.

## 11 Implant Insertion

Insert the implant into the radius using the Head Impactor (TR-MS05) and a mallet. Ensure that the laser mark on the head is aligned with the lateral aspect of the radius when the forearm is in neutral position. Lister's tubercle may also be used as a landmark for laser mark orientation.

**Cement Option:** If desired, the prosthesis may be cemented into position. The same anatomic landmarks as previously described are used to ensure proper alignment. Select an implant that is one size smaller than the reamer to allow for a 0.5 mm cement mantle. A higher viscosity cement should be used to allow precoating of the stem prior to implantation. The precoat is applied while the cement is malleable. Prior to stem insertion, malleable cement may be inserted into the radial canal. Insert into its anatomic position and hold the elbow in a flexed position while the cement hardens. Check for cement extrusion around the radial neck and remove if present. Once the cement is firm and cooled (per the cement IFU), the elbow can be moved freely as needed.

Optionally, a cement restrictor (not available through Acumed) may be inserted approximately 1 cm distal to the tip of the implant to prevent extravasation down the intramedullary canal of the radius and to improve the cement mantle.



Standard Stem Implant  
(TR-SXXXX-S)



Morse Taper Impactor Block  
(80-1506)



Head Implant  
(TR-H2XXX-S)



Head Impactor  
(TR-MS05)



# Anatomic Radial Head – Standard Stem Surgical Technique [continued]

## 12 Postoperative Protocol

Postoperative management is determined by the overall management of the elbow and limb, as though the radial head had never been fractured. For isolated fractures of the radial head and neck without ligament injury, early motion is commenced in flexion and extension as well as pronation and supination. This usually begins within the first few days after surgery.

**Note:** An ARH Removal Tool Shaft (80-2018) is available in the system for stem removal if needed. For removal instructions, reference the Anatomic Radial Head and Stem Removal technique on page 22.

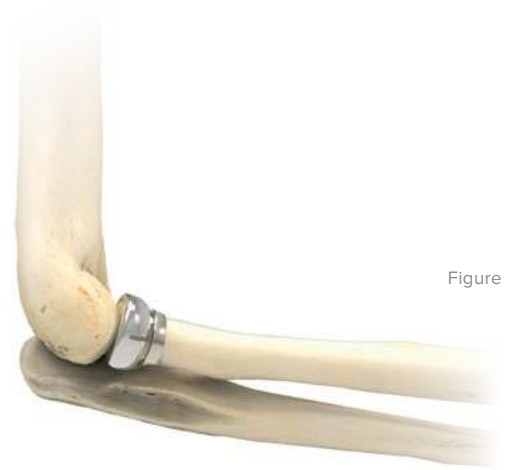

Figure 16



ARH Removal Tool  
Shaft  
(80-2018)

# Anatomic Radial Head – Long Stem Surgical Technique

Shawn W. O’Driscoll, PhD, MD

Figure 1

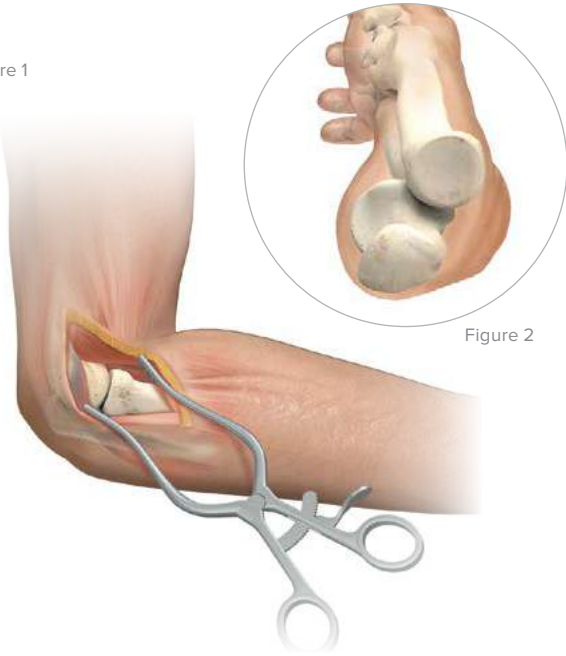

Figure 2

## 1 Incision and Dissection

There are several exposure options, depending on the integrity of the lateral soft tissues. In fracture-dislocations, the exposure is through the traumatic opening in the ligament complex. For delayed reconstructions, and in those acute cases in which the lateral collateral ligament is intact, the Kaplan interval permits the ligament to be left intact. The deep incision is placed in a line from the lateral epicondyle toward Lister’s tubercle, with the forearm in neutral rotation. Proximally, the extensor carpi radialis longus (ECRL) origin is released with the anterior capsule to permit direct access to the front of the radial head.

**Note:** Stem removal can be very difficult if a fully porous coated surface is well ingrown with bone. Slap hammers and vice grips are useful. If revising an Acumed Anatomic Radial Head and Stem, an ARH Removal Tool Shaft (80-2018) is available for the stem. A removal technique is available on page 22. After stem removal, find the radial canal distal to the end of the primary stem before reaming. This can be done with a small pointed device such as a Rush reamer.

**Note:** Image intensification (fluoroscopy) can be helpful in avoiding cortical perforation.



ARH Removal Tool  
Shaft  
(80-2018)

# Anatomic Radial Head – Long Stem Surgical Technique [continued]

## 2 Radial Head/Neck Resection

1. Place the Long Stem Resection Guide (6, 8, 10, 12 mm) (80-1512) against the capitellum and in line with the radial neck.
2. Score the bone with a blade. If there is no bone at the 6 mm level, proceed with sequential reaming.
3. Resect at the 6 mm level within the resection guide using an Osteotomy Saw Blade Hub Style L or S (80-0739-S or 80-0740-S) or .6 mm thick blade. This resection level will remove enough neck to allow the reamers to be directly inserted into the radial canal.

**Note:** The long stem reamers are 0.25 mm undersized from the implants.

**Note:** An ARH Long Stem X-Ray Template (90-0039) is available for preoperative planning.

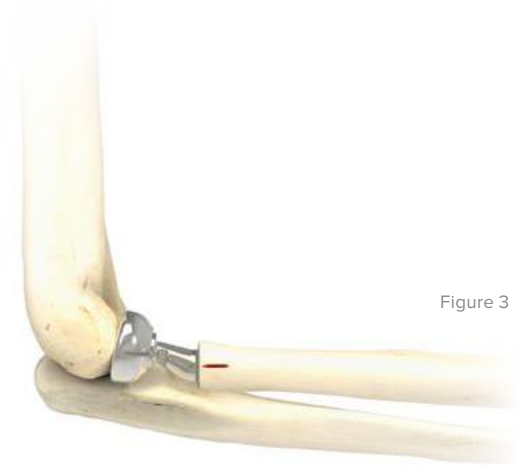

Figure 3

The amount of resection varies with the stem diameter shown:

### Resection Reference Chart

Stem Diameter	Resection Length
6 mm	19 mm
8 mm	22 mm
10 mm	25 mm
12 mm	28 mm

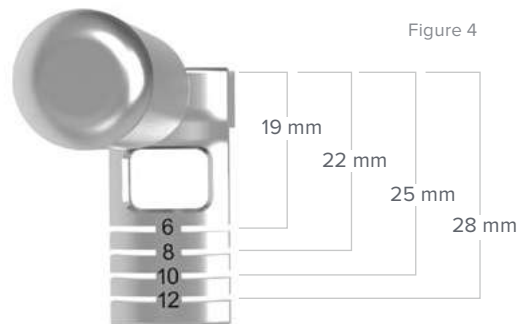

Figure 4

### ARH Long Stem Lengths Reference Chart

Stem Diameter	Long Stem Length
6 mm	50 mm
8 mm	55 mm
10 mm	60 mm
12 mm	65 mm



Figure 5



Long Stem Resection Guide (6, 8, 10, 12 mm) (80-1512)



Osteotomy Saw Blade Hub Style L or S (80-0739-S or 80-0740-S)

# Anatomic Radial Head – Long Stem Surgical Technique [continued]

Figure 6



## 3 Determine Stem Diameter

Use the 5.5 mm Quick Release Awl (TR-0206) to initially enter the canal. With the Bone Graft Ratcheting T-Handle (BG-8043) attached to the smallest Long Stem Reamer 6 mm (80-1706), prepare the canal for the stem using sequentially larger reamers until a tight fit is achieved. A Radius Retractor (80-1509) is available to elevate the radius. If the final reamer diameter size is greater than 6 mm (i.e., 8, 10, or 12 mm), re-cut the radial neck using the Long Stem Resection Guide (80-1512) and microsagittal saw to the length corresponding to the final reamer diameter size (i.e., 8, 10, or 12 mm). After re-cutting the neck, re-insert the same size reamer until the laser mark band is even with the level of resection.

**Note:** The long stem reamers are 0.25 mm undersized from the implants.

Figure 7



## 4 Determine Head Diameter

Determine the head diameter by placing the resected head upside down in the sizing pockets on the Morse Taper Impactor Block (80-1506). If between sizes, select the smaller diameter.

Figure 8



5.5 mm Quick Release Awl (TR-0206)



Bone Graft Ratcheting T-Handle (BG-8043)



Long Stem Reamer 6 mm (80-1706)



Radius Retractor (80-1509)



Long Stem Resection Guide (6, 8, 10, 12 mm) (80-1512)



Morse Taper Impactor Block (80-1506)

# Anatomic Radial Head – Long Stem Surgical Technique

## [continued]

### 5 Select Trial Implants and Assemble

After selecting the Trial Head (TR-TH2XX) and Trial Morse Taper Long Stem (TR-TSLXXX), align the laser marks on the head and stem and assemble using hand pressure. The stem laser mark is indicated Left or Right (“L” or “R”) for proper orientation. If the trial head and stem are difficult to connect, apply saline solution prior to connecting.

**Note:** Left-specific trials are blue and right-specific trials are green.



Figure 9

### 6 Trial Implant Insertion

Rotate the forearm to a neutral rotation. Mark the lateral aspect of the radial neck with the cautery (in line with Lister’s tubercle). The stem laser mark is indicated Left or Right (“L” or “R”) for proper orientation. Insert the trial into the radius. Insert to the level of the laser mark (line around stem body) or when the appropriate reduction is achieved.

**Note:** If restoration length is too long, additional reaming and reinsertion of the trial is suggested. Ensure the dotted laser mark on the stem is aligned with the cautery mark. The Morse Taper Long Stem Alignment Guide (80-2127) can be used to help with alignment during insertion. Check for proper articulation with the capitellum and the coronoid. The coronoid needs to be in contact with the trochlea to ensure proper positioning of the trial.

**Note:** Trial components are NOT designed to be implanted.

**Note:** The Trial Morse Taper Long Stems (TR-TSLXXX) are the same diameter as the reamers.

**Caution:** Do NOT impact the trial long stem into the canal. If the trial cannot be placed at the insertion line without impaction, then recheck the reaming depth or resection cut.

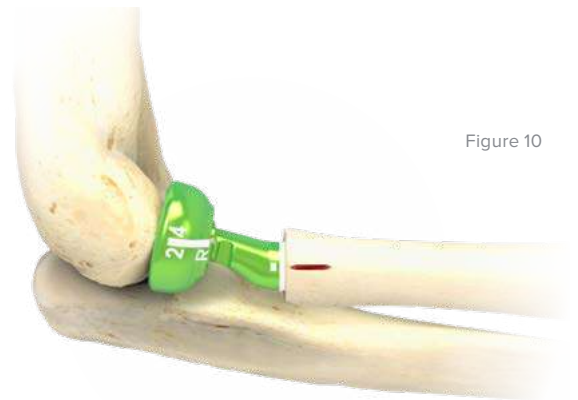

Figure 10



Trial Head  
(TR-TH2XX)



Trial Morse Taper  
Long Stem  
(TR-TSLXXX)



Morse Taper Long  
Stem Alignment  
Guide  
(80-2127)

# Anatomic Radial Head – Long Stem Surgical Technique

## [continued]



Figure 11



Figure 12

## 7 Implant Assembly

After determining the correct size head and stem with the trials, place the Morse Taper Long Stem implant (TR-SLXX-S) into the long stem impaction site on the Morse Taper Impactor Block (80-1506). Align laser marks and assemble the Head Implant (TR-H2XXX-S) and stem using hand pressure, then lock the Morse Taper engagement between the head and stem using the Head Impactor (TR-MS05) and a mallet.

**Note:** The Long Stem implants are identified by stem diameter only. The left (L) and right (R) designations are marked directly on stem. Ensure that your head implant is aligned with the correct side of the Long Stem implant.

## 8 Implant Insertion

Insert the assembled implant into the radius using the Head Impactor (TR-MS05) and a mallet. Insert to the level of the laser mark (line around stem body) or when the appropriate reduction is achieved. Ensure that the dotted laser mark on the stem is aligned with the cautery marking on the lateral aspect of the radius when the forearm is in neutral rotation. The Morse Taper Long Stem Alignment Guide (80-2127) can be used to help with alignment during insertion. Check for proper articulation with the capitellum and the coronoid. Lister's tubercle may also be used as a landmark for laser mark orientation.

**Cement Option:** If desired, the prosthesis may be cemented into position. The same anatomic landmarks as previously described are used to ensure proper alignment. Select an implant that is one size smaller than the reamer to allow for a 1 mm cement mantle. A higher viscosity cement should be used to allow precoating of the stem prior to implantation. The precoat is applied while the cement is malleable. Prior to stem insertion, malleable cement may be inserted into the radial canal. Insert into its anatomic position and hold the elbow in a flexed position while the cement hardens. Insert to the level of the second dot below the laser mark (line around the stem body) or when the appropriate reduction is achieved. Check for cement extrusion around the radial neck and remove if present. Once the cement is firm and cooled (per the cement IFU), the elbow can be moved freely as needed.

Optionally, a cement restrictor (not available through Acumed) may be inserted approximately 1 cm distal to the tip of the implant to prevent extravasation down the intramedullary canal of the radius and to improve the cement mantle.

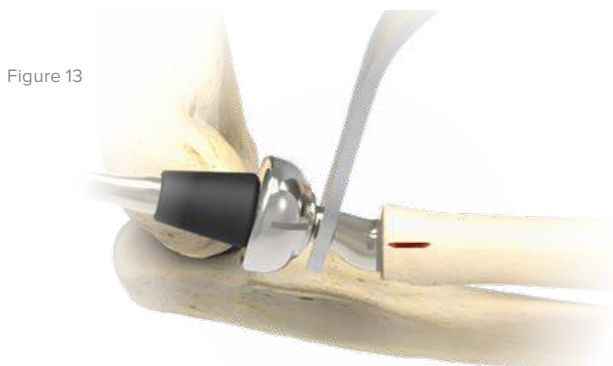

Figure 13

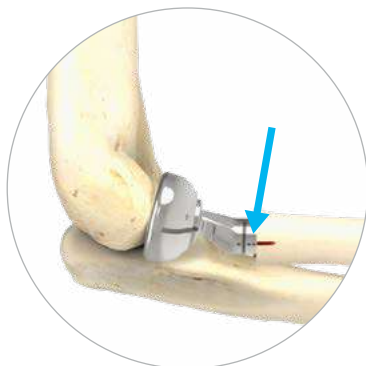

Figure 14



Morse Taper Long Stem implant (TR-SLXX-S)



Morse Taper Impactor Block (80-1506)



Head Implant (TR-H2XXX-S)



Head Impactor (TR-MS05)



Morse Taper Long Stem Alignment Guide (80-2127)

# Anatomic Radial Head – Long Stem Surgical Technique [continued]

## 9 Postoperative Protocol

**Note:** The following protocol may be replaced with an alternative protocol at the performing surgeon's discretion.

Postoperative management is determined by the overall management of the elbow and limb, as though the radial head had never been fractured. For isolated fractures of the radial head and neck without ligament injury, early motion is commenced in flexion and extension as well as pronation and supination. This usually begins within the first few days after surgery.

**Note:** An ARH Removal Tool Shaft (80-2018) is available in the system for stem removal if needed. For removal instructions, reference the Anatomic Radial Head and Stem Removal technique on page 22.

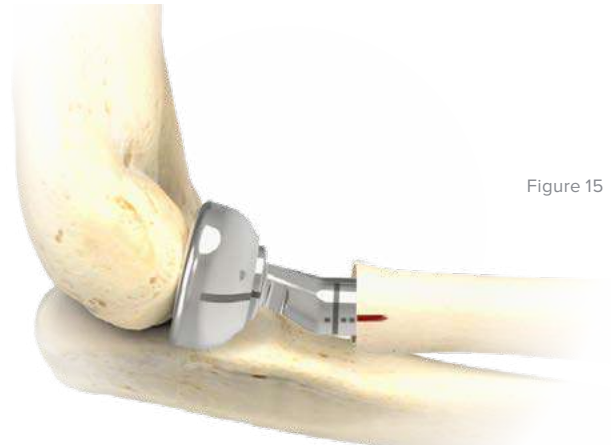

Figure 15



ARH Removal Tool  
Shaft  
(80-2018)

# Anatomic Radial Head and Stem Removal Surgical Technique

Shawn W. O'Driscoll, PhD, MD

Figure 1



## 1 Head Removal

To remove the radial head prosthesis from the standard stem, place an osteotome in the Morse taper gap between the head and the stem and tap with a mallet.

If removing a +0 mm collar Standard Stem (TR-S0XXX-S) where there is no Morse taper gap, attach a vice grip to the head and then attach a slap hammer to the vice grip. Use the slap hammer to separate the implant head from the stem.

To remove the radial head prosthesis from a long stem (TR-SLXX-S), use the same vice grip technique as above.

Figure 2

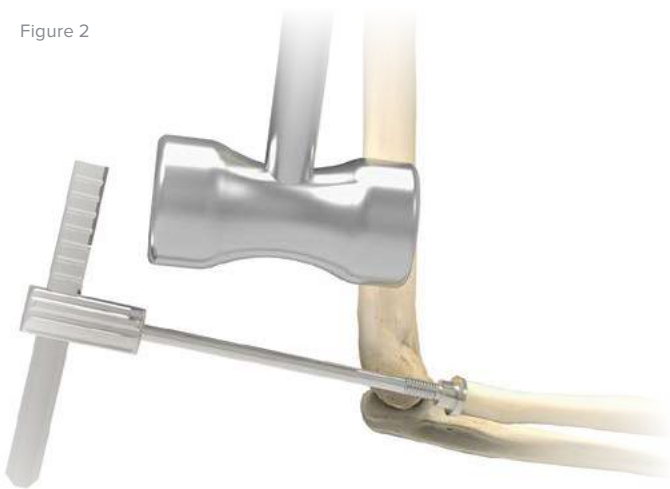

## 2 Stem Removal

To remove a Standard Stem (TR-SXXXX-S) or a Morse Taper Long Stem (TR-SLXX-S) from the canal, thread the ARH Removal Tool Shaft (80-2018) into the stem. Insert the Cross Bar (80-1771) through the handle of the ARH Removal Tool Shaft. Using a mallet, tap the cross bar until the stem is removed from the canal.



Standard Stem  
(TR-SXXXX-S)



Morse Taper  
Long Stem  
(TR-SLXX-S)



ARH Removal Tool  
Shaft  
(80-2018)



Cross Bar  
(80-1771)



# Ordering Information

Implants			
<b>Standard Stem Implants</b>		<b>Head Implants</b>	
6.0 mm x 0.0 mm Stem	TR-S0600-S	20.0 mm Head, Left	TR-H200L-S
6.0 mm x 2.0 mm Stem	TR-S0602-S	22.0 mm Head, Left	TR-H220L-S
6.0 mm x 4.0 mm Stem	TR-S0604-S	24.0 mm Head, Left	TR-H240L-S
6.0 mm x 6.0 mm Stem	TR-S0606-S	26.0 mm Head, Left	TR-H260L-S
6.0 mm x 8.0 mm Stem	TR-S0608-S	28.0 mm Head, Left	TR-H280L-S
7.0 mm x 0.0 mm Stem	TR-S0700-S	20.0 mm Head, Right	TR-H200R-S
7.0 mm x 2.0 mm Stem	TR-S0702-S	22.0 mm Head, Right	TR-H220R-S
7.0 mm x 4.0 mm Stem	TR-S0704-S	24.0 mm Head, Right	TR-H240R-S
7.0 mm x 6.0 mm Stem	TR-S0706-S	26.0 mm Head, Right	TR-H260R-S
7.0 mm x 8.0 mm Stem	TR-S0708-S	28.0 mm Head, Right	TR-H280R-S
8.0 mm x 0.0 mm Stem	TR-S0800-S		
8.0 mm x 2.0 mm Stem	TR-S0802-S	<b>Long Stem Implants</b>	
8.0 mm x 4.0 mm Stem	TR-S0804-S	6 mm Morse Taper Long Stem	TR-SL06-S
8.0 mm x 6.0 mm Stem	TR-S0806-S	8 mm Morse Taper Long Stem	TR-SL08-S
8.0 mm x 8.0 mm Stem	TR-S0808-S	10 mm Morse Taper Long Stem	TR-SL10-S
9.0 mm x 0.0 mm Stem	TR-S0900-S	12 mm Morse Taper Long Stem	TR-SL12-S
9.0 mm x 2.0 mm Stem	TR-S0902-S		
9.0 mm x 4.0 mm Stem	TR-S0904-S		
9.0 mm x 6.0 mm Stem	TR-S0906-S		
9.0 mm x 8.0 mm Stem	TR-S0908-S		
10.0 mm x 0.0 mm Stem	TR-S1000-S		
10.0 mm x 2.0 mm Stem	TR-S1002-S		
10.0 mm x 4.0 mm Stem	TR-S1004-S		
10.0 mm x 6.0 mm Stem	TR-S1006-S		
10.0 mm x 8.0 mm Stem	TR-S1008-S		

## Ordering Information [continued]

Tray Components			
<b>Trial Stems</b>		<b>Instrumentation</b>	
7	6 mm Trial Morse Taper Long Stem, Right	TR-TSL06R	9 ARH Removal Tool Shaft 80-2018
8	6 mm Trial Morse Taper Long Stem, Left	TR-TSL06L	10 Bone Graft Ratcheting T-Handle BG-8043
5	8 mm Trial Morse Taper Long Stem, Right	TR-TSL08R	11 Radius Retractor 80-1509
6	8 mm Trial Morse Taper Long Stem, Left	TR-TSL08L	15 Long Stem Reamer 6 mm 80-1706
1	10 mm Trial Morse Taper Long Stem, Right	TR-TSL10R	14 Long Stem Reamer 8 mm 80-1708
2	10 mm Trial Morse Taper Long Stem, Left	TR-TSL10L	13 Long Stem Reamer 10 mm 80-1710
3	12 mm Trial Morse Taper Long Stem, Right	TR-TSL12R	12 Long Stem Reamer 12 mm 80-1712
4	12 mm Trial Morse Taper Long Stem, Left	TR-TSL12L	20 Standard Stem Reamer 6 mm 80-1606
			19 Standard Stem Reamer 7 mm 80-1607
			18 Standard Stem Reamer 8 mm 80-1608
			17 Standard Stem Reamer 9 mm 80-1609
			16 Standard Stem Reamer 10 mm 80-1610
			21 Cross Bar 80-1771
Optional Components			
	Osteotomy Saw Blade Hub Style L	80-0739-S	Osteotomy Saw Blade Hub Style S 80-0740-S

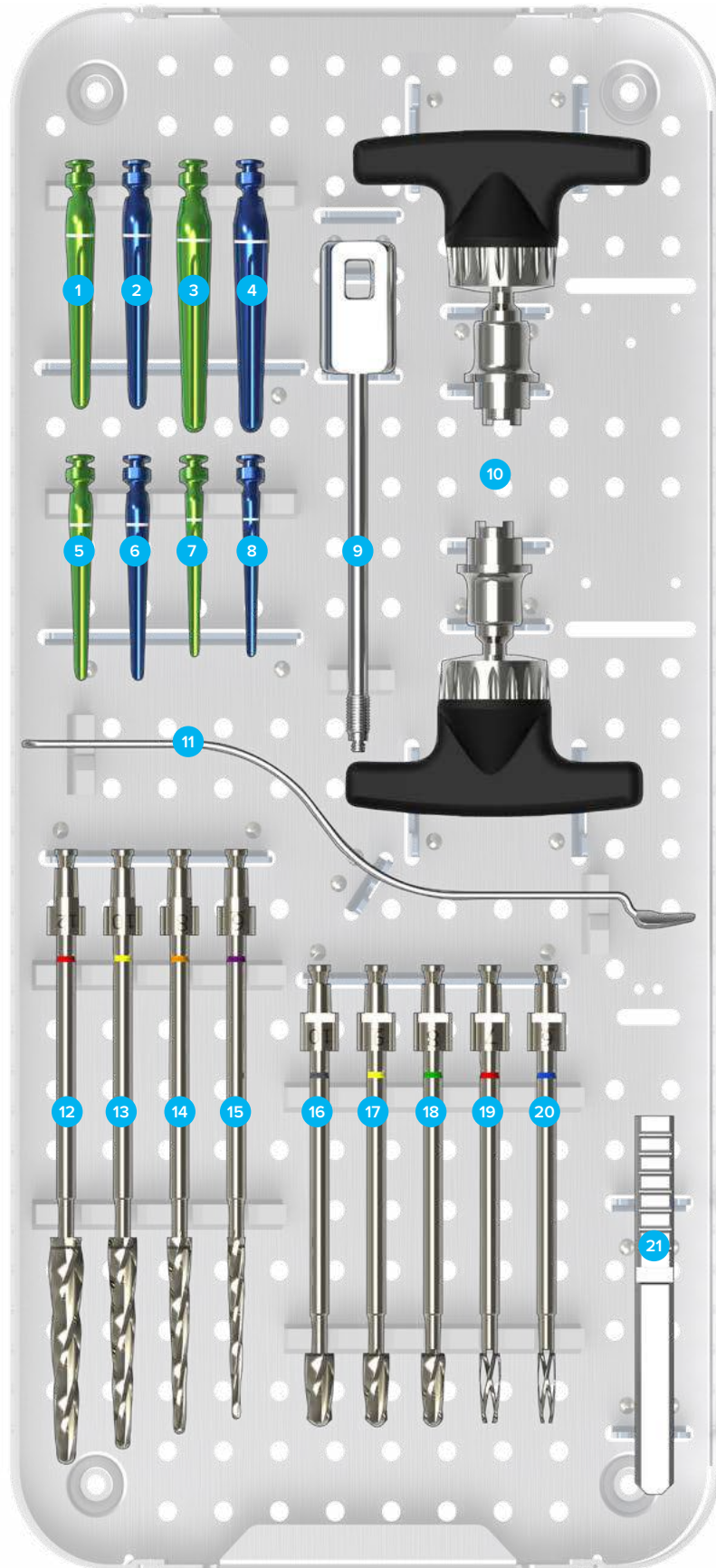

## Ordering Information [continued]

Tray Components					
<b>Instrumentation</b>		<b>Trial Stem Implants</b>			
1	6.0 Stem Gauge Assembly	TR-TGA06	45	6 mm x 0 mm Trial Stem	TR-TS60
2	Height Gauge	TR-TG02	46	6 mm x 2 mm Trial Stem	TR-TS62
3	Trial Gauge	TR-TG01	47	6 mm x 4 mm Trial Stem	TR-TS64
4	Morse Taper Impactor Block	80-1506	48	6 mm x 6 mm Trial Stem	TR-TS66
5	Medium Ratcheting Driver Handle	80-0663	49	6 mm x 8 mm Trial Stem	TR-TS68
6	Head Impactor	TR-MS05	40	7 mm x 0 mm Trial Stem	TR-TS70
7	6 mm Collar Reamer	TR-CRA06	41	7 mm x 2 mm Trial Stem	TR-TS72
8	7 mm Collar Reamer	TR-CRA07	42	7 mm x 4 mm Trial Stem	TR-TS74
9	8 mm Collar Reamer	TR-CRA08	43	7 mm x 6 mm Trial Stem	TR-TS76
10	9 mm Collar Reamer	TR-CRA09	44	7 mm x 8 mm Trial Stem	TR-TS78
11	10 mm Collar Reamer	TR-CRA10	35	8 mm x 0 mm Trial Stem	TR-TS80
12	AT2 Screw Sizer	AT2-SMCZ	36	8 mm x 2 mm Trial Stem	TR-TS82
13	5.5 mm Quick Release Awl	TR-0206	37	8 mm x 4 mm Trial Stem	TR-TS84
14	Long Stem Resection Guide (6, 8 10, 12 mm)	80-1512	38	8 mm x 6 mm Trial Stem	TR-TS86
<b>Trial Head Implants</b>		39		8 mm x 8 mm Trial Stem	TR-TS88
22	20 mm Trial Head, Right	TR-TH20R	30	9 mm x 0 mm Trial Stem	TR-TS90
21	20 mm Trial Head, Left	TR-TH20L	31	9 mm x 2 mm Trial Stem	TR-TS92
24	22 mm Trial Head, Right	TR-TH22R	32	9 mm x 4 mm Trial Stem	TR-TS94
23	22 mm Trial Head, Left	TR-TH22L	33	9 mm x 6 mm Trial Stem	TR-TS96
16	24 mm Trial Head, Left	TR-TH24L	34	9 mm x 8 mm Trial Stem	TR-TS98
15	24 mm Trial Head, Right	TR-TH24R	25	10 mm x 0 mm Trial Stem	TR-TS100
18	26 mm Trial Head, Left	TR-TH26L	26	10 mm x 2 mm Trial Stem	TR-TS102
17	26 mm Trial Head, Right	TR-TH26R	27	10 mm x 4 mm Trial Stem	TR-TS104
20	28 mm Trial Head, Left	TR-TH28L	28	10 mm x 6 mm Trial Stem	TR-TS106
19	28 mm Trial Head, Right	TR-TH28R	29	10 mm x 8 mm Trial Stem	TR-TS108



## References

1. Sahu D, Holmes DM, Fitzsimmons JS, Thoreson AR, Berglund LJ, An KN, O'Driscoll SW. Influence of radial head prosthesis design on radiocapitellar joint contact mechanics. *J Shoulder Elbow Surg.* 2014 Apr;23(4):456-62.
2. Bachman DR, Thaveepunsan S, Park S, Fitzsimmons JS, An KN, O'Driscoll SW. The effect of prosthetic radial head geometry on the distribution and magnitude of radiocapitellar joint contact pressures. *J Hand Surg Am.* 2015 Feb;40(2):281-8.
3. Doornberg JN, Linzel DS, Zurakowski D, Ring D. Reference points for radial head prosthesis size. *J Hand Surg Am.* 2006 Jan;31(1):53-7.





Acumed Headquarters  
5885 NE Cornelius Pass Road  
Hillsboro, OR 97124  
Office: +1.888.627.9957  
Office: +1.503.627.9957  
Fax: +1.503.520.9618  
[www.acumed.net](http://www.acumed.net)

These materials contain information about products that may or may not be available in any particular country or may be available under different trademarks in different countries. The products may be approved or cleared by governmental regulatory organizations for sale or use with different indications or restrictions in different countries. Products may not be approved for use in all countries. Nothing contained in these materials should be construed as a promotion or solicitation for any product or for the use of any product in a particular way that is not authorized under the laws and regulations of the country where the reader is located. Nothing in these materials should be construed as a representation or warranty as to the efficacy or quality of any product, nor the appropriateness of any product to treat any specific condition. Physicians may direct questions about the availability and use of the products described in these materials to their authorized Acumed distributor. Specific questions patients may have about the use of the products described in these materials or the appropriateness for their own conditions should be directed to their own physician.

**ELB10-01-C** | Effective: 2020/08 | © 2020 Acumed® LLC